

WATER-COOLED



THREE PHASES



50 HZ



STAGE 2



DIESEL



DIESEL GENERATOR SET 50 Hz

Service		Standby	Prime
Power	kVA	110	100
Power	kW	88	80
Speed	r.p.m	1500	
Standart Voltage	V	24	
Power Factor	Cos Phi	0,8	

KZPOWER has ISO 9001, ISO 14001 and OHSAS 18001 quality certifications.

KZPOWER gensets are compliant with EC mark which includes the following directives:

- 2006/42/CE Machinery safety.
- 2014/30/UE Electromagnetic compatibility.
- 2014/35/UE electrical equipment designed for use within certain voltage limits
- 2000/14/EC Sound Power level. Noise emissions outdoor equipment. (amended by 2005/88/EC)
- 97/68/EC Emissions of gaseous and particulate pollutants. (amended by 2002/88/EC & 2004/26/EC)
- EN 12100, EN 13857, EN 60204

Ambient conditions of reference according to ISO 8528-1:2005 normative: 1000 mbar, 25°C, 30% relative humidity.

G2 class load acceptance in accordance with ISO 8528-5:2013

ENGINE

Service	Specifications	
Brand	RICARDO	
Model	R6105AZLD	
Engine Type	4 Stroke - Diesel	
Injection Type	Direct Injection	
Aspiration Type	Turbo Charge, After Cooler	
Number of cylinders and arrangement	6 In line	
Bore&Stroke	mm	105x130
Displacement	L	6,75
Cooling System	Water Cooling	
Compression Ratio	18:01	
Fuel Consumption Standby	l/h	22,561
Fuel Consumption 100% PRP	l/h	20,51
Fuel Consumption 75 % PRP	l/h	15,38
Fuel Consumption 50 % PRP	l/h	13,33
Total oil capacity including tubes, filters	L	18
Total coolant capacity	L	25
Governor	Type	Mechanical/Electronic

Standard Generator Features

- Heavy duty water cooled diesel engine and brushless alternator
- Solid steel base frame with minimum 8 hours base tank and anti-vibration mountings
- AMF Control panel with digital-automatic main control module
- 50C Tropical radiator
- Battery charge redressor. Lead acid battery
- Residential type silencer
- Flexible exhaust compensator
- Block water heater unit
- All rotating parts are covered by metal mesh against damages
- Engine and alternator manufacturer test reports (if provided)
- Factory load, performance and function tests
- User Manual, Electrical Drawing and Gurantee certificate

Note

All data based on operation to ISO 3046/1, BS 5514 and DIN 6271 standard reference conditions.

ALTERNATOR



GNT-110

KZR -G110

Service	Specifications
No of Phases	3
Power Factor	0,8
No of Bearings	Single
No of Poles	4
No of Leads	6-12
Insulation Class	H
Degree of Protection	IP23
Excitation System	AVR

Prime Power (PRP)

According to ISO 8528-1:2005, Prime power is the maximum power which a generating set is capable of delivering continuously whilst supplying a variable electrical load when operated for an unlimited number of hours per year under the agreed operating conditions with the maintenance intervals and procedures being carried out as prescribed by the manufacturer. The permissible average power output (Ppp) over 24 h of operation shall not exceed 70 % of the PRP.

Emergency Standby Power (ESP):

According to ISO 8528-1:2005, Emergency standby power is the maximum power available during a variable electrical power sequence, under the stated operating conditions, for which a generating set is capable of delivering in the event of a utility power outage or under test conditions for up to 200 h of operation per year with the maintenance intervals and procedures being carried out as prescribed by the manufacturers. The permissible average power output over 24 h of operation shall not exceed 70 % of the ESP.

DIMENSIONS

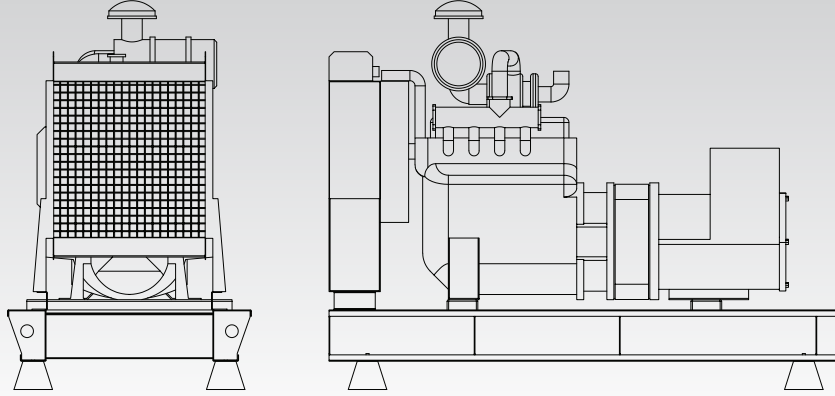

OPEN TYPE

LxWxH	mm	2460x1100x1740
Weight	kg	1400
Fuel Tank Capacity	lt	310

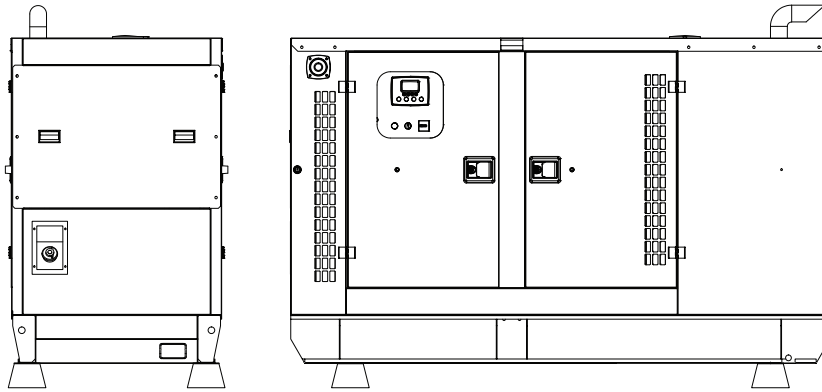

CANOPIED

LxWxH	mm	2980x1100x2000
Weight	kg	1715
Fuel Tank Capacity	lt	310

Sound Proof Canopy Specifications

- Special design for minimizing acoustic level
- Galvanized steel construction further protected by polyester powder coat paint
- Black finish stainless steel locks and hinges
- Control panel viewing window in a lockable access door
- Emergency stop push button (red) mounted on enclosure exterior
- Lifting, drag and jacking points on base frame
- Radiator fill via removable, flush mounted rain cap fitted with compression seal

CONTROL UNIT

STANDART



OPTIONAL

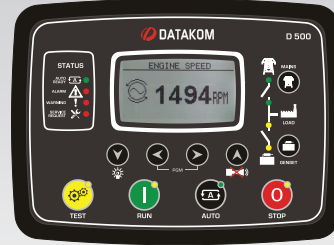

D300 - DATAKOM

4-band GPRS modem (optional)
 USB Device
 RS-232 (2400-57600baud)
 J1939-CANBUS
 Geo-locating through GSM
 GPS support (RS-232)
 Internet Central Monitoring
 SMS message sending
 E-mail sending
 Free PC software: Rainbow Plus
 Modbus RTU

D500 - DATAKOM

Ethernet (10/100Mb)
 4-band GPRS modem (optional)
 USB Host & USB Device
 RS-485 (2400-115200baud)
 RS-232 (2400-115200baud)
 Micro SD card slot
 J1939-CANBUS
 Geo-locating through GSM
 GPS support (USB & RS-232)
 Embedded web server
 Web monitoring & programming
 Internet Central Monitoring
 SMS message sending
 E-mail sending
 Free PC software: Rainbow Plus
 Modbus RTU & Modbus TCP/IP
 SNMP (with TRAP messages)
 SNTP

ATS PANEL



KZ Power transfer switches are ideal for emergency, standby power applications. The KZ Power transfer switch is available in several different control configurations to meet the requirements of your load transfer application.

KZ POWER's contactor based transfer switch is rated 40–3600A and can be supplied in separate enclosure for stand-alone applications or can be supplied as an integral component. Contactors inside the ATS panels are well known and internationally recognized brands such as ABB, LS/LG, SCHNEIDER, GE and ANDELI.

OPTIONAL EQUIPMENTS

Some of our Optional Equipments which can be provided with Generator Sets But not limited to;

- Medium voltage alternator
- Remote radiator applications
- External fuel tanks. Automatic and Manuel fuel filling system from external fuel tanks
- Fuel tank heater, oil pan heater, Anti-condensation heater
- Alternator with PMG (Permanent Magnet Generator)
- Synchronization systems
- Double Walled Fuel Tanks
- Container type canopy
- Lube oil and fuel drain pumps
- Trailer
- Remote monitoring options on the control panel
- Electronic fuel level indicator

